



VICTORIA POLICE

VICTORIA POLICE

Police Employment Suitability Testing

Candidate Information Booklet





VICTORIA POLICE

VP41929

Police



AXON

Contents

Background	4
Victoria Police Values	4
Eligibility	4
About the role	5
What does a General Duties Police Officer do?	6
Recruitment Process	6
Role of ACER	7
About the Victoria Police Entrance Examination	8
Test Components	8
Test Dates and Centres	9
Registration Fees	9
Refunds	10
Session Changes and Deferrals	10
Special Testing Consideration	10
Test Centre Procedures and Regulations	12
Admission Ticket	12
Reporting to the Test Centre	13
Identification on the Test Day	13
Security	13
Permitted Items	13
Leaving Early	13
Misconduct and Penalties	14
Infringement of Copyright	14
Results	15
Victoria Police Entrance Examination Results	15
Currency of Results	15
Re-sitting	16
Appeals	16
Preparation Strategies	17
Preparation Materials	17
Official Practice Resources	17
Internet Research	17
Literacy Skills	18
Reading	18
Writing	18
Oral Communication	18
Digital Literacy skills	18
Reasoning Tests – (Verbal and Abstract)	19
Numeracy Skills	20
Sample Questions	21
Literacy Skills (Reading)	21
Practice Questions	22
Sample Literacy Questions	24
Summary Writing Task	26
Sample Response	28
Extended Writing Task	29
Oral Communication Task	33
Digital Literacy	34
Digital Literacy Sample Questions	35
Sample Questions Answers	39
Reasoning Test	40
Numeracy Skills	44
Sample Questions Answers	49
Legal Notice	52





Background

Victoria Police Values

Victoria Police provides policing services to the Victoria community 24 hours a day, 7 days a week working to keep Victorians safe. We are committed to ensuring that all our people follow our core values:

- Integrity
- Leadership
- Flexibility
- Respect
- Support
- Professionalism
- Safety

Eligibility

TO BECOME A VICTORIA POLICE MEMBER YOU MUST:

- Be 18 years old or over.
- Be an Australian citizen or have permanent residency.
- If you are under 21, you must have passed the Victorian Certificate of Education (VCE) or equivalent. The Senior Level Victorian Certificate of Applied Learning (VCAL) is also accepted.
- Meet eligibility requirements regarding criminal and traffic convictions.
- Meet medical standards.
- Be fit and ready to work in a demanding and physically challenging role.
- In addition to the above eligibility requirements, police applicants must hold a current Australian driver's licence or probationary licence.



About the role

The people of Victoria rely on police to protect life and property, detect and apprehend offenders, and help those in need of assistance. Therefore, a police officer performs duties that are diverse, stimulating and challenging. First you must complete a 31 week training phase, then you will be deployed as a general duties police officer to a police station somewhere in Victoria.

General duty police officers are the foundation of Victoria Police and are essential to ensure that the Victorian community functions safely. General duty officers are always the first on the scene at any reportable crime or public need and provide their service to the community 24 hours a day, 7 days a week.

The majority of Victoria Police members work as general duties police officers but there are also many specialist roles that require further training and usually at least 4 years general duties operational experience as a pre-requisite.



VICTORIA POLICE



For more information on the application process and to apply go to the Victoria Police website: <https://www.police.vic.gov.au/police>





What does a General Duties Police Officer do?

Duties are varied and you will come into contact with people from all walks of life. Some of the people you deal with will display values and behaviours that contradict your own. However, as a police officer you are required to remain impartial. Below is a list of some of the situations that you may have to manage as a general duties police officer:

- prevent anti-social behaviour
- deal with community safety concerns
- resolve disputes
- attend at accidents
- investigate crime
- enforce traffic law
- deal with drug and alcohol affected people
- attend critical incidents and emergencies

You are required to submit paperwork on most situations you attend including keeping a running sheet which is an ongoing diary of the duties you perform during each shift. You will also be required to prepare paperwork for court and subsequently attend hearings and give evidence.

While the role of a police officer is challenging, it is also rewarding; as a police officer you will make a difference to the Victorian community every day.

It is vital that applicants understand all stages of the Victoria Police application process and comply with the minimum entry requirements before submitting an application.

Recruitment Process

The Victoria Police recruitment process involves a number of stages designed to determine an applicant's suitability for the role.

1. Submit an application online
2. Eligibility Checks
3. Entrance Exam
4. Preliminary Checks
5. Video Interview
6. Fitness Test
7. Psychological Testing
8. Health Checks
9. Comprehensive Checks
10. Panel Interview
11. Candidate Pool

It is vital that applicants understand all stages of the Victoria Police application process and comply with the minimum entry requirements before submitting an application.



Role of ACER

The Victoria Police Entrance Examination is delivered by the Australian Council for Educational Research (ACER) (an independent national research and development organisation) on behalf of Victoria Police. ACER is responsible for the administration of the entrance examinations and will provide results directly to Victoria Police. Victoria Police will manage all other recruitment stages.

COMMUNICATING WITH THE REPRESENTATIVE OF VICTORIA POLICE, ACER OFFICE

If you have any queries about the Entrance Exam, you should contact the ACER Victoria Police Office.

Email: vicpol@acer.org

Web: <https://vpol.acer.org>

Phone: (03) 9277 5299

Postal address: Private Bag 55, Camberwell VIC 3124

Email is the principal means of communication for the Victoria Police Entrance Exam. Please monitor your emails regularly and advise ACER of any updates to your email address. ACER will endeavour to respond within 3 business days, so please contact ACER if you have not received a response within this timeframe, to ensure your message has been received.



Please Note: If your email address is hosted by a webmail provider such as Gmail or Hotmail, some procedures implemented by these providers may result in some email messages not being accepted, or being flagged as spam. Please add vicpol@acer.org to your address book to ensure emails from the Victoria Police ACER Office are not filtered as junk email.

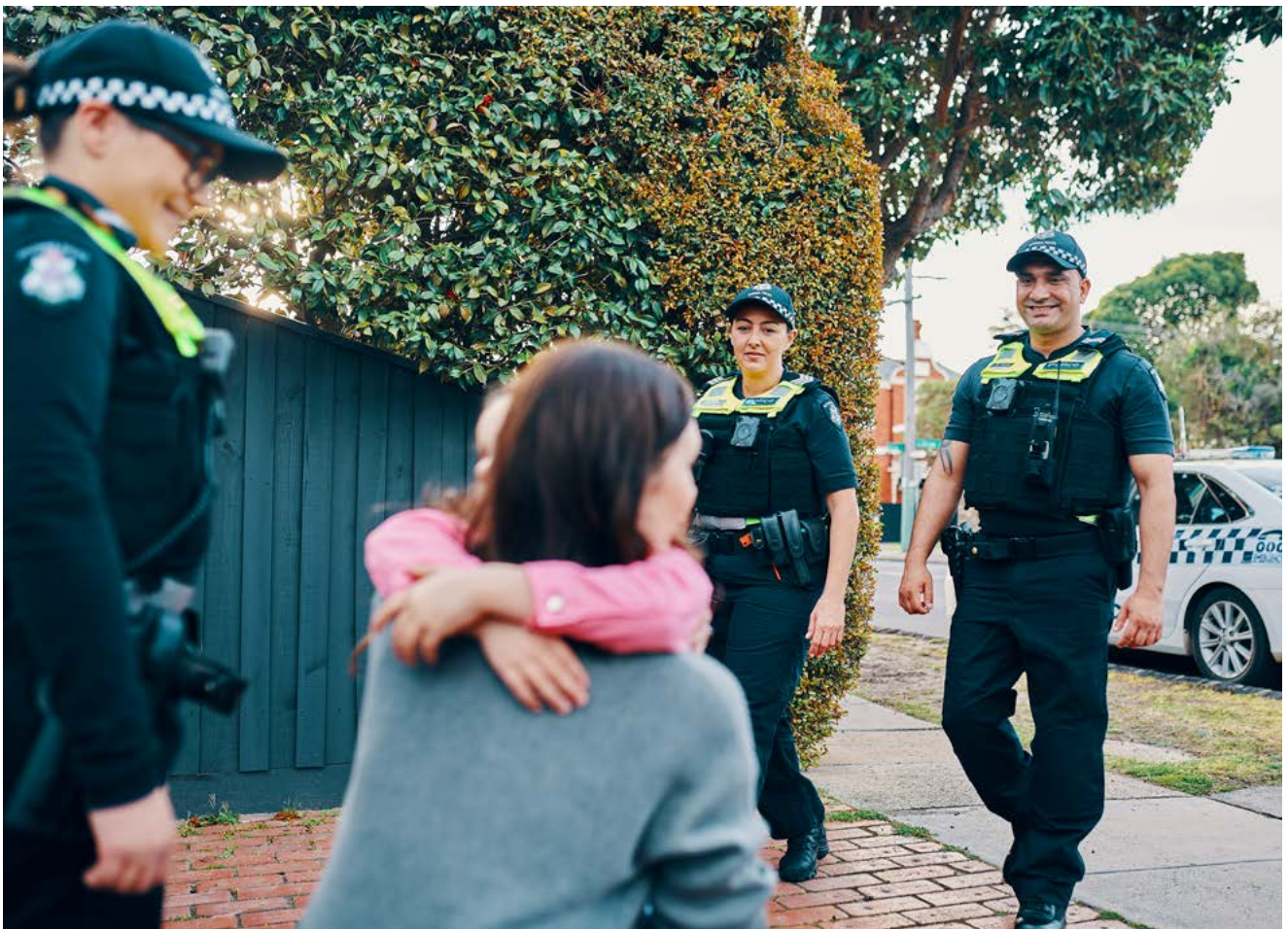



About the Victoria Police Entrance Examination

Test Components

The Victoria Police Entrance Examination is a computer-based assessment, made up of eight (8) individually timed and scored components. All candidates planning to sit the Victoria Police Entrance Examination will be required to register and attend an Australian Council for Educational Research (ACER) test centre.

Candidates need to allow approximately 4 and a half hours for the entire testing session (there will be a 15 minute break during the test administration).

To be selected for progression to the next stage of the Victoria Police Recruitment process, candidates must obtain a score at or above the pass marks for each component listed in the table below.

Test Section	Type of Assessment	Number of Questions	Time Allowed	Pass Mark
Literacy Skills*	Online Multiple Choice	30	35 min	111
Summary Writing	Typed task	1	20 min	14/20
Extended Writing	Typed Essay	1	45 min	14/20
Verbal Reasoning	Online Multiple Choice	34	15 min	15/34
Numeracy Skills*	Online Numeric Entry and Multiple Choice	30	35 min	111
Abstract Reasoning	Online Multiple Choice	45	20 min	32/45
Oral Assessment	Online Audio Response	5	10 min	14/20
Digital Literacy*	Online Response	20	20 min	107

*Scored against the Australian Core Skills Framework (ACSF) – the Australian standards for adult literacy, numeracy and digital literacy.



Test Dates and Centres

Tests are run on a monthly basis during the day on weekends. Testing will be offered near the following locations:

Metropolitan Centres	Regional Centres	Regional Centres
Box Hill	Ballarat	Adelaide
Dandenong	Bendigo	Brisbane
Preston	Geelong	Darwin
Melbourne City	Mildura	Hobart
Mulgrave	Shepparton	Perth
St Albans	Traralgon	Sydney
Werribee	Warrnambool	
	Wodonga	

When completing your online registration, select the day and session which is most convenient for you. You should plan your travel carefully so that you arrive at the test centre approximately ten (10) minutes before the reporting time listed on your ticket.



Please Note: A minimum of eight (8) candidates will be required for a sitting to go ahead. If a session is cancelled due to a lack of candidates you will be notified and allocated into your second preference centre.

Registration Fees

The fee to sit the Victoria Police Entrance Examination is \$220 (GST inc). When you register online you may also pay by credit card (Mastercard, AMEX, Diners or Visa, including Visa and Mastercard debit cards).

The online payment option operates through an e-commerce facility on the ACER website. Credit card details are not recorded or stored by ACER but are encrypted at point of capture and transmitted direct to the bank, without entering ACER information systems. Thus you can be assured this is a safe payment option.



For more information on the test content see the Test Preparation section page 16



Refunds

You may be entitled to a refund of your registration fee under the Australian Consumer Law in certain limited circumstances. Up until seven (7) business days prior to your scheduled sitting of the Victorian Police Entrance Examination you may request a refund beyond those limited circumstances. After that date you may only request a refund in the limited circumstances allowed by the Australian Consumer Law, more specifically, where there has been a serious failure in the goods or services provided under these terms and conditions.

REFUND TERMS

1. Where the limited circumstances of the Australian Consumer Law allowing a refund do not apply to your request for a refund, you will be charged a \$50 administrative charge;
2. should you register for, but not sit, the Victorian Police Entrance Examination, without prior notification and where the limited circumstances where a refund is allowed under the Australian Consumer Law do not apply, your registration fee will not be refunded; and such circumstances may eliminate you from applying to the Victoria Police for a period of 6 months from the scheduled test date;
3. ACER reserves the right to absolutely refuse or cancel a registration in circumstances where your registration is not bona fide or is not received seven days prior to your sitting of the Victorian Police Entrance Examination; and
4. all requests for a refund must be made in writing by email to: vicpol@acer.org



Session Changes and Deferrals

You are able to change your booking up to seven (7) business days prior to your allocated test session; after this time no session changes will be permitted.

To change your session please go to:
<https://vicpolreg.acer.org>

Log in to the Candidate Login page using the details previously provided to you by email.

Application ID number: XXXXXX
Password: XXXXXXXXXX

Please Note: Seats in each session will be allocated on a first in, first served basis. ACER and Victoria Police do not guarantee that applicants will be able to reserve a seat in any given session.

If you need to change your session within seven (7) business days of your session you may apply in writing by email to vicpol@acer.org. You must have a valid reason with supporting documentation (such as medical certificate).

If you cannot attend your booked session due to medical reasons, a medical certificate will be required within 3 days of the assessment. A single deferral opportunity will be provided.

If you book a test session but do not attend without notifying ACER your application to Victoria Police will be void and you risk a six (6) month delay in applying again.

ACER reminds candidates that when you book in for an exam, you are committing to this date and time. Please select carefully, as you will only be permitted to make one change to your exam session.

Special Testing Consideration

ACER will make alternative testing arrangements subject to approval from Victoria Police. All applicants wishing to apply for special testing consideration should contact Victoria Police to discuss their needs. Victoria Police will work with ACER to ensure equitable testing arrangements are made where reasonably practicable.

PRIVACY, PERSONAL INFORMATION AND SENSITIVE DATA

By completing the Victoria Police Entrance Examination registration form you agree to be bound by the ACER privacy policy and therefore consent to:

- a. ACER collecting your personal information including any sensitive (such as health) information. The personal information ACER may collect about you includes your registration information, your payment details, your test answers and results, any application for special testing conditions and any communications you have with the Representative of Victoria Police, ACER Office;
- b. ACER using and disclosing the personal information we collect about you for purposes connected with your Victoria Police application and testing which may include investigating any suspected misconduct and administering any penalty for misconduct. You understand that if you do not provide us with all the information requested, we may not be able to process your

Victoria Police Entrance Examination registration or test or respond to your communications; your personal (including sensitive) information being disclosed by ACER to the Victoria Police and other persons or bodies connected with Victoria Police for purposes related to Victoria Police (which may include transferring it overseas); and

- c. ACER using your personal information for research purposes and disclosing it to relevant research bodies (in a de-identified form). Candidate names will be separated from data in all cases.

All information collected will be treated with utmost confidentiality and we will take all reasonable steps to ensure its security. Any use of your registration and test records will be treated with the utmost confidentiality. We will strictly adhere to our obligations under the Privacy Act 1988 (Cth) and any other applicable data protection legislation.

For more information about our privacy policy and how to access or correct your information, please see <https://www.acer.org/privacy>





Test Centre Procedures and Regulations

Admission Ticket

You will receive an email five (5) business days prior to the date of your exam, confirming that your admission ticket is now available to download from your Candidate Registration Portal, located at: <https://vicpolreg.acer.org>

To access your ticket you will need the details previously provided to you by email.

Application ID number: XXXXXX
Password: XXXXXXXXX



Please Note: You are advised to add vicpol@acer.org to your address book prior to registering.

When completing your online registration, you must upload a current photograph, similar in style to a passport photo. This photo will appear on your Admission Ticket. Photos may be uploaded at the time of registering. **The Admission Ticket must be printed and taken with you to the test centre**, it will be collected by a supervisor as testing is completed and returned to ACER.

IMPORTANT:

If you arrive at a test centre without a printed copy of your admission ticket, you will be refused entry and will not be permitted to sit the test. There will be no exceptions.

Please check your Admission Ticket carefully and email ACER immediately if there are any errors.

Reporting to the Test Centre

At the time of registering you will be allocated a seat in your chosen session. You must report to the exam centre at the time listed on your Admission Ticket. At this time the exam supervisors will begin registration and complete pre-exam procedures. Your exam will begin once registration is complete. We suggest arriving to report to the exam centre venue approximately ten (10) minutes prior to the reporting time.

If you report to the centre after all candidates have been seated in the testing room you may not be admitted. No latecomers can be admitted once the test has started.

When you report to the test centre you must bring:

- Admission Ticket – with photo included
- Suitable and current photo identification (see below)
- Pen

Identification on the Test Day

Acceptable identification is as follows:

- Current Photo-Bearing Drivers Licence (learner permit, probationary, or full licence)
- Current Passport
- Current photo-bearing Australian Keypass

You will be required to show your identification, together with your printed Admission Ticket, to supervisors at the test centre.

If for any reason you cannot provide your photo identification on the test day (e.g. because of a lost wallet) you must provide a signed statutory declaration confirming your identity. You must also provide by email or mail a certified copy of your driver licence to the ACER Victoria Police office no later than three (3) business days after your allocated test sitting. Failure to do so may result in results being withheld.

The Victoria Police Entrance Examination is a high stakes test. Security procedures which have been outlined in this booklet will be strictly enforced at all times.

Security

The Victoria Police Entrance Examination is a high stakes test. Therefore ACER, in conjunction with the Victoria Police, has established security procedures which have been outlined in this booklet and will be strictly enforced at all times.

Permitted Items

No dictionaries, calculators or electronic equipment of any kind are permitted during the test.



Please Note: Mobile phones, pagers, calculators, stopwatches, audio or recording devices of any kind (including MP3 players), note paper, food and bags will not be permitted in the test room. Pencil cases, highlighters and rulers are not permitted.

You may bring a bottle of drinking water into the test centre with you.

Leaving Early

The Victoria Police Entrance Examination is a high stakes test administered under secure conditions. You may not leave the test centre before the full testing time has elapsed, except in the case of illness. In this instance, you are required to provide a medical certificate explaining your need to leave the test centre within three (3) business days of the test administration; failure to do so may result in results being withheld.

Once a candidate has departed the test centre it is not possible to re-enter and continue the test.



Misconduct and Penalties

Misconduct includes:

- breach of any of the security arrangements for the Victoria Police Entrance Exam;
- impersonation;
- attempting to copy or memorise all or part of the test, or to take any notes, from the testing room;
- failure to follow test supervisor's instructions at all times;
- giving or receiving assistance during the test;
- creating a disturbance;
- using prohibited aids (e.g. notes, note paper, calculator, mobile phone, audio/recording device etc.);
- accessing computer based resources, including applications and websites, outside the authorised exam platform.
- copying another candidate's work;
- using the test questions, their content or information about them for purposes other than your sitting of the Victoria Police Entrance Exam. This includes: publishing the examination questions or any of their content or information about them on the internet, any digital format or otherwise; and/or passing the Victoria Police Examination questions, any of their content or information about them to third parties;
- the giving of false or misleading information; infringement of copyright. This includes: performing those acts which only the copyright holders may do or authorising or allowing a person on the candidate's behalf to infringe Victoria Police or ACER's copyright material.
- PENALTIES for misconduct include: withholding of your Victoria Police Entrance Examination results or disqualification from sitting the exam in the future. YOU ARE PUT ON NOTICE that there is NO APPEAL from any penalty applied.

Infringement of Copyright

The Victoria Police Entrance Examination is copyright material owned by ACER and Victoria Police. Any infringement of the Victoria Police Entrance Examination copyright material, in addition to any right at law, will be treated as misconduct for the purposes of the agreement you sign at the time of registration.

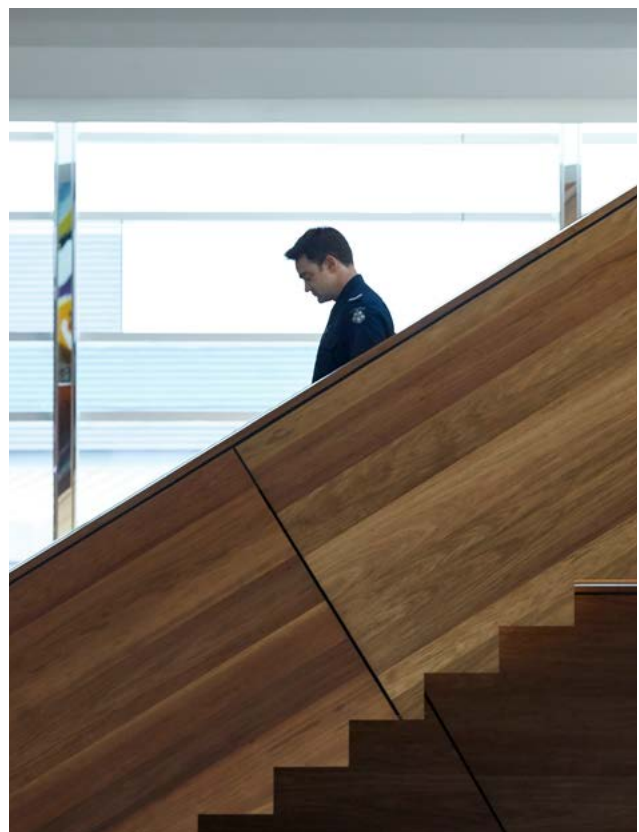



Results

Victoria Police Entrance Examination Results

ACER will advise you by email when you can access your results. Candidates will be advised to go to the login page at: <https://vicpolreg.acer.org>

Application ID number: XXXXXX
Password: XXXXXXXXX

Results will take approximately seven (7) business days to process after the test date. To be selected to progress to the next stage of the Victoria Police recruitment process, you must obtain a score at or above the pass marks listed for each section in the table below. You will be required to download a copy of your results to your own computer as access to the portal will be available for a limited time.

You will receive a score for each of the eight (8) test components.

Victoria Police will be advised of your results soon after you receive them from ACER. If you pass all components, Victoria Police will correspond with you via e-mail to advise you of the next stage in the selection process. If you fail any components on your first attempt, it will be your responsibility to book yourself in to re-sit the failed components. There is no waiting period. You may re-sit the failed components at the next available booking. All re-sits must be booked and sat within two (2) months from the date of your first attempt. If you fail any components of your re-sit attempt, Victoria Police will also correspond with you via e-mail to advise you of the status of your application.

Currency of Results

Victoria Police Entrance Examination results are valid for a period of three (3) years from the date that you **passed** all components of the test.

Literacy Skills	Summary Writing	Extended Writing	Verbal Reasoning	Abstract Reasoning	Numeracy Skills	Oral Assessment	Digital Literacy
111	14/20	14/20	15/34	32/45	111	14/20	107



Re-sitting

Victoria Police allow two attempts per application to successfully pass all components of the Entrance Exam. If you failed one or more components, you will have the opportunity to re-sit. Candidates are only required to re-sit the exam components they have failed. All passing marks remain valid.

To book a re-sit, candidates will need to log in to the [registration system](#) and follow the instructions for booking a re-sit, via the 're-sit failed sections' link at the bottom of the page.

The candidate registration system will automatically display dates that are available for you to book. Re-sit exams are run every month and are open at venues until they reach capacity. Please check another venue if your first preference is not available.

Candidates have two (2) months in total to complete your re-sit. If it is not completed in this timeframe, the application may be cancelled with Victoria Police.

Candidates who do not pass all failed exam components on their second attempt will need to wait six (6) months from their re-sit date before re-applying with Victoria Police again. Upon re-application, you will be given a new application ID number and will be required to sit the entire exam again.

The cost to re-sit*:

Re-sit one component	\$80
Re-sit two components	\$160
Re-sit three or more components	\$220

Appeals

Requests for re-marking will only be considered for the following components of the exam, and the costs are as follows:

Summary Writing	\$55.00
Extended Writing	\$55.00
Oral Assessment	\$55.00

Due to result turnaround time frames, you are only eligible to apply for an appeal after your second attempt/re-sit. ACER will not accept re-mark requests after your first attempt of the Entrance Exam.

To apply for a re-mark please submit your request in writing, via email to ACER at vicpol@acer.org. Applications must be received within five (5) business days of

receiving results. After this time, no appeals will be actioned.

No other test components will be considered. ACER and Victoria Police will not enter into appeals against results for the following test sections:

[Literacy Skills](#)
[Digital Literacy](#)
[Abstract Reasoning](#)
[Verbal Reasoning](#)
[Numeracy Skills](#)

Should you wish to query a particular question on the day of the test, you should alert the supervisor to your concern and submit an incident report before you leave the test centre. Your query will be reviewed by the ACER Victoria

Police Office and you will be notified of the outcome.

Similarly, any complaints relating to the test venue or physical discomfort suffered should be reported to the supervisor on the day, or in writing to the ACER Victoria Police Office within three (3) days of the test administration day.

It is not possible to give special consideration for impaired performance on the day of the test caused by illness or other unexpected personal situations.

Further information on the ACER Complaint and Appeals Policy is available at: https://www.acer.org/files/ACER_TAVAS_Complaint_and_Appeals_Policy.pdf

*Please refer to refunds policy on page 10.



Preparation Strategies

Preparation Materials

Sample questions are provided in this booklet by Victoria Police and ACER and can assist you to improve your skills.

It is recommended you attempt these questions to identify areas needing development then continue practising to improve your results. You may choose to complete the sample questions several times to become familiar with the types of questions you will encounter in the exam. It is also a good idea to time yourself so you become familiar with time constraints.

Official Practice Resources

A full set of Online Practice Tests are available for purchase at the time of registering. These may also be purchased after an exam booking has been finalised by returning to the Candidate Booking portal. The online practice tests provide timed, full tests similar in design and difficulty to those

in the final exam. Online tests can be purchased individually or as a set.

ACER also provides the Practise Now! Victoria Police Exam book for purchase. This publication identifies specific skills required, describes a range of question types you are likely to encounter and provides detailed explanations of how correct answers may be reached. The Practise Now book may be purchased in hard copy before registering for an exam via the ACER Shop, or via the candidate booking portal as an e-book.

Internet Research

You can also use all the relevant assessment tools available on the Internet. You may wish to use the following search strings to access information and tools to help you prepare:

- Literacy self assessment
- Literacy sample test questions
- Literacy practice tests
- Oral communication test sample
- Speech and oral communication sample



Literacy Skills

Literacy skills are improved through a combination of practising reading, writing, listening and speaking. To improve these literacy skills, it is suggested that you read and write daily, and practise listening and speaking.

Below are some general tips to improve your literacy skills. They have been broken up into the areas of reading, writing and oral communication.

Reading

1. Read something different than what you normally read and read more! E.g. read the newspaper from front to back each day.
2. Read each article all the way through, then re-read them and identify the main points.
3. Scan before you read the article in full as this will give you an understanding of what it's about before you read the details.

Writing

1. After reading a newspaper article, write a summary of the main points and key supporting evidence.
2. Watch a piece on television or YouTube then write a description of what you saw and a summary of the footage.
3. Re-read your pieces of writing the next day - be critical about your work and challenge yourself to find areas you can improve.
4. Ask another person to review your writing and provide feedback.

Oral Communication

Oral communication involves listening, including the ability to interpret information, and speaking, including the ability to convey the meaning of your message.

1. Speak as often as possible to as many people as possible - practising will help you improve.
2. Listen to a news bulletin or watch an article on television with another person then explain the details of what you saw to them.

3. Read out loud and listen for your mistakes.
4. Arrange social events where you can practise your speaking and listening skills with other people.

Digital Literacy Skills

Digital Literacy skills are improved through practising your use of digital devices, software and applications. You can practise your skills by undertaking everyday tasks and activities that use digital devices and technology. Practise connecting to, managing and using your devices, such as desktop computers, laptops, mobile devices (tablets, phones), Wi-Fi, and their different software and applications, such as emails, word processing, spreadsheets, virus programs, messaging, saving documents, and making appointments. Use the internet to search for information or to apply for services, or purchase goods, etc. Think about how you find the best and most trustworthy information.

Know about personal and private security and privacy issues related to the digital world.



Self-improvement

It is recommended that candidates take steps to ensure they are adequately prepared for the Victoria Police Entrance Examination.

To achieve the best possible results, a number of strategies can be used to prepare for this examination.



Reasoning Tests – (Verbal and Abstract)

The Verbal and Abstract reasoning tests are designed to measure these abilities as demonstrated by the capacity to think logically, see relationships and solve problems. The tests are primarily intended as a measure of general cognitive ability for selection into occupations that involve a moderate to high level of demand on reasoning ability, and for other purposes where the ability to think clearly is involved. The reasoning tests are multiple choice format for the Verbal and Abstract reasoning. It is recommended that you work steadily through the test. It is not advisable to spend too much time on any one question. Try each question as you come to it. Answer the questions you find easiest first. If you find a question is too difficult, leave it and come back to it later if you have time. For the Verbal and Abstract reasoning read through all the alternative answers to a question, even if you think the first one is correct, before marking your chosen response. If you think you know the answer to a question, mark it, even if you are not certain. Go on to the next question and come back later if you have time.

Please note the following:

- All questions have the same value, therefore by attempting as many questions as possible you stand the best chance of maximising your score.
- No marks are deducted for a wrong answer.

VERBAL REASONING

Verbal reasoning is the ability to understand and reason using concepts framed in words. It aims at testing your ability to think logically, understand relationships, solve problems and think critically, rather than simply understanding vocabulary.

ABSTRACT REASONING

The abstract reasoning assessment is used to measure the ability to think clearly to solve problems and quickly identify patterns and logical rules based on abstract visual patterns rather than numbers and words. It involves recognising the rule or rules that govern the progression of a pattern from one diagram to another in a series, or to identify the part which is missing from a diagram.



Tests are run on a monthly basis, check the website <http://vpol.acer.org> for the most up-to-date information on test dates.



Numeracy Skills

The Numeracy assessment measures your ability to understand, use, apply and interpret problems where mathematics is embedded in a context. The questions can be based on numerical and mathematical data and situations presented in words, tables, graphs, plans and diagrams etc. The numeracy questions are set in a range of different contexts relevant to adults. The maths content can include questions about number and algebra, measurement and geometry and statistics and probability.

Read through the questions carefully and write down any notes on the working paper to help you make calculations before entering your answer. If you think you know the answer to a question, enter it, even if you are not certain – you can always change it later. If you find a question too difficult, or hard to understand, leave it and go on to the next question and come back later if you have time.

Numeracy skills are improved through using and practising your maths skills by solving everyday

maths problems – look at the sample questions later in the booklet to get an idea of what sort of skills you need to practise. To improve your numeracy skills, it is suggested that you practise doing a range of calculations with money, including with percentages, rates and ratios; doing some measurement based calculations around area and volume; and reading and interpreting some data and statistics, including when represented in graphs and charts.

Note: A basic scientific calculator can be used to practice for the Numeracy Skills assessment. An on screen calculator will be provided for the exam. No other calculators will be permitted for use during the exam.

We recommend using a scientific calculator for practice, similar to those used in secondary school. (Mobile phone calculators are not recommended for practice as they form simplistic calculations and do not match the function of the on screen version provided for the exam).





Sample Questions

The sample questions included in this booklet are examples of the types of items in the assessments but do not necessarily indicate the full range of questions or their difficulty. They are designed to provide some guidance about what to expect and to help you to prepare for the test. However, success in the sample questions does not guarantee or imply success in the actual assessment.

Literacy Skills (Reading)

The Literacy Skills (Reading) assessment requires you to demonstrate competent use of English language to read and comprehend different documents and texts. You will be given about six different texts to read and answer 30 questions in total. Most of these will be multiple choice questions, but others may require a short written response or to answer, for example, 'true' or 'false' or 'yes' or 'no' to a number of alternative answers to a set of questions or statements about a text. Samples of the types of questions are included below.

You will be expected to show your understanding and skills related to reading processes such as understanding the purpose of a text, using prediction and prior knowledge, and demonstrating critical reading and text analysis skills. As well you will be expected to show a range of reading strategies such as text navigation, comprehension, decoding and fluency, syntax and language patterns and vocabulary.

The questions in the Literacy (Reading) assessment are mapped against the Australian Core Skills Framework (ACSF) – the Australian standards for adult literacy and numeracy. The results of the assessment are reported on a scale that goes from a minimum of 40 up to a maximum of about 170. A score of 111 or greater is considered to be at Exit level 3 of the ACSF or higher and this is the required pass mark.

Time allowed: 35 minutes.



Practice Questions:

SAMPLE LITERACY QUESTIONS

Tell MetroCorp to
move the new freeway entrance



The new MetroLink freeway plans have missed the opportunity to take noisy, polluting, dangerous trucks off our suburban roads. The proposed freeway entrance will:

- start only 200m away from houses, a local school and a community centre
- have a raised road which will mean dangerous goods will be carried over homes
- dig up the Mulberry Creek Reserve, destroying 30 years of regeneration work.

Why not use the empty industrial land on the southern side of the freeway?

Tell MetroCorp to stop cost-cutting and extend the freeway away from residential streets!

Have your say!! Email MetroCorp about this issue at community@metrocorp.com.au

City Truck Action Group

Friends of Mulberry Creek

- 1 What is the purpose of this poster?
- A to persuade MetroCorp not to go ahead with building the freeway
 - B to persuade people that the MetroLink freeway should not be built
 - C to highlight the problems with the freeway entrance location and to persuade people to write to MetroCorp
 - D to convince people that the problem with trucks in suburban areas is that they are noisy, polluting and dangerous
- 2 Why are the Friends of Mulberry Creek involved in this issue?
- A they are concerned about the safety of park users
 - B they are concerned about truck noise affecting park users
 - C they are concerned about the environmental effects of trucks
 - D they are concerned that the park they look after will be ruined
- 3 The poster uses the term 'cost-cutting'. Which phrase could be used instead of 'cost-cutting' without changing the meaning?
- A saving time
 - B saving space
 - C saving money
 - D saving materials
- 4 Does this poster use the following arguments for moving the freeway entrance?
Tick Yes or No for each argument.
- | | | |
|--|------------------------------|-----------------------------|
| a park will be ruined | <input type="checkbox"/> Yes | <input type="checkbox"/> No |
| local streets will be closed off during construction | <input type="checkbox"/> Yes | <input type="checkbox"/> No |
| trucks with dangerous loads will travel over houses | <input type="checkbox"/> Yes | <input type="checkbox"/> No |
- 5 'Let's work together to make our suburb safer, healthier and truck free.'
Which group of people does this suggest the poster is aimed at?
- A Truck drivers
 - B Local residents
 - C The government
 - D Managers at MetroCorp



Processed meats cause cancer



Eating processed meats can cause cancer, and red meat is also likely to cause the disease according to researchers at the World Health Organisation (WHO).

Cancer experts at WHO analysed over 800 studies that investigated links between eating red meat, processed meat and cancer. The studies included many countries and populations with diverse diets.

WHO experts concluded that each 50 gram portion of processed meat eaten daily increases the risk of colorectal cancer by 18%. They also found links between pancreatic cancer and prostate cancer and eating processed meat.

Kurt Straif, Head of the Monographs Programme at the International Agency for Research on Cancer (IARC), the cancer agency of WHO, said that while the risk of developing colorectal cancer from eating processed meat is small, "this risk increases with the amount of meat consumed". Given the large number of people around the world that eat processed meat, Straif said, "the global impact on cancer incidence is of public health importance".

The IARC referred to research from the Global Burden of Disease Project, an independent academic research

organisation estimating that about 34,000 cancer deaths per year worldwide are attributable to diets high in processed meat.

Processed meat includes ham, sausages, bacon, hot dogs, salami, corned beef, beef jerky and as well as canned meat and meat-based sauces.

"These findings further support current public health recommendations to limit intake of meat," said Dr Christopher Wild, Director of IARC. Wild said that given red meat has nutritional value, the results enabled governments and international regulatory agencies to identify "the risks and benefits of eating red meat and processed meat and to provide the best possible dietary recommendations".

The report prompted a strong reaction from the meat industry. "There is no causal link between red meat and cancer", the Australian Meat Industry Council (AMIC) said in a statement, citing evidence from a journal published this year. The AMIC statement argued that meat provides essential nutrients and that broader lifestyle factors need to be considered when evaluating the risk of cancer.

6 According to the news report, which of the following is true?

Tick Yes, No or Not stated for each statement.

Eating 50 grams of ham every day can make you 18% more likely to get cancer. Yes No Not stated

The way that processed meat is cooked is a factor in how likely it is to cause cancer. Yes No Not stated

Eating red meat definitely causes cancer. Yes No Not stated

Over 30 000 people die every year from cancer linked to eating high levels of processed meat. Yes No Not stated

7 Which sentence best describes the information presented in the article?

- A** There is a small chance of developing cancer from eating processed meat that increases if more meat is eaten.
- B** Cancer experts think that eating processed meat and red meat may cause cancer but the results are inconclusive.
- C** People can safely eat a small amount of processed meat as long as they have a healthy lifestyle and a balanced diet.
- D** Eating red meat and processed meat is very likely to give you cancer and the chance will increase if more meat is eaten.

8 The news report uses quotes. Quotes are used in news reports for a range of reasons.

Which of the following is not a reason why quotes were included in this news report?

- A** to back up the opinion of the writer
- B** to provide differing opinions or facts
- C** to make the article seem more authoritative
- D** to provide information straight from the source of the research

9 On which topic do WHO experts and the Meat Industry Council disagree?

- A** red meat can be nutritious
- B** red meat can cause cancer
- C** processed meat can cause cancer
- D** eating more processed meat increases the risk of cancer

10 If the risk of developing colorectal cancer from eating processed meat is small, what is the importance of the study?

- A** Over 800 studies were analysed to determine the findings.
- B** Cancer is a serious disease affecting many people around the world.
- C** A large number of people in the world that eat processed meat are affected.
- D** WHO is an important organisation and people should know about their research.



Summary Writing Task

The Summary Writing Task requires you to write (in typed form on a computer) a concise set of notes summarising the main ideas and the key supporting details in a passage of text. Write in note form. You do not need to write in full sentences, but your notes must be comprehensible to a reader unfamiliar with the original text.

Candidates should:

- give your Summary a title
- use bullet points, numbering and headings/sub-headings
- use correct or accepted spelling, abbreviations and punctuation conventions, and work within acceptable grammatical rules appropriate to the style of writing
- use appropriate language
- use a style of writing suited to the original audience and purpose
- plan the response so that ideas are expressed logically
- write approximately 100 words or more if you wish.

Time allowed: 20 minutes

Practice Questions

See following pages.

Text

The Australian National Identification card was first raised at the National Tax summit in 1985 as a way to amalgamate government identification systems and reduce the ability to avoid tax and commit health and welfare fraud. The Federal government was keen to introduce legislation to streamline identification for Australian citizens. However, the bill was not passed by the parliament.

Ewart Smith, a retired public servant, noticed some flaws in the draft legislation. Certain regulations necessary for the operation of the ID card system could be overturned by the Senate, which, at the time, was hostile to the idea of the card. As a result, the ID card for Australian citizens was dropped.

After the 2005 London terrorist bombings, the Australian Government once again proposed the introduction of the Australian ID card as a way to help the government combat terrorism and address flaws in the immigration system. The Government believed that an ID card would make a person's ability to enter Australia under a false identity more difficult and this would deter potential terrorists.

In 2005, critics of the Australian ID card both in Parliament and the general community believed the ID card would infringe on the privacy rights of Australian citizens. The card was seen as an unnecessary piece of bureaucracy that the current Australian passport and Tax File Number systems already addressed.

Ultimately, the idea of an Australian National Identification card has been shelved. However, in today's current climate of international terrorism, it can never be ruled out.

Your task

- Write a summary of the text
- This should be an accurate and concise set of notes which identifies the main points and key supporting details of the text.

Advice to Candidates

- Give your summary a title
- Write in note form (you do not need to write in full sentences)
- You may use bullet points, numbering, headings and/or sub-headings to clarify your notes
- Length – write approximately 100 words or more if you wish.



Sample Response

Note that this sample response is provided as a model only – it is not an exemplar or the only approach that could be used to write a summary writing response.

Title: Mandatory Australian ID Cards

The First Proposal

- ID card first proposed to help group together different gov systems related to citizen ID
- may help cut down on tax, health, and welfare fraud
- also streamline id for citizenship
- however proposal was not passed by the parliament
- flaws found in proposed legislation by public servant Ewart Smith
- senate was hostile, flaws would have allowed it to overturn the proposed system.

The Second Proposal

- ID card proposed second time after 2005 London terror bombings
- supposed to help stop terrorism
- also help with problems in immigration system
- however backlash because of privacy
- also criticised as unnecessary, as needs already covered by Australian passports and tax file numbers.

Conclusion

- the ID card was not introduced, but because we live in the climate/threat of global terrorism, the idea won't go away.

Extended Writing Task

The Extended Writing Assessment requires you to produce a clear, fluent piece of writing (in typed form on a computer) based on the two arguments given.

You should:

- pay attention to spelling, punctuation and grammar as all English skills will be assessed
- structure the piece of writing appropriately, e.g. include a beginning, a body and a conclusion
- use appropriate language
- use a style of writing suited to the audience and purpose
- plan the response so that ideas are expressed logically
- aim to write approximately 300-350 words or more if you wish.

Time allowed: 45 minutes

Practice Questions:

Read the two texts below. They express two different viewpoints on the same question.

Your task

Write your own contribution to this discussion. Give your opinion on the issue of whether the retirement age should be raised, and explain the reasons for your view.

You may comment on the logic and/or evidence provided by the two writers in their comments.

You may use any other information that you think is relevant.

Advice to Candidates

- Plan your time
- You must write in complete sentences.



Your writing will be assessed on the following points:

Logical Structure

- Does it have an introduction and a conclusion?
- Is it organised into clear logical paragraphs?
- Have you supported each point you make with relevant reasons?

Writing Style

- Is the writing clear and to the point?
- Can the reader understand what you mean on first reading?
- Is the tone appropriately formal?
- Have you used words accurately?

Writing Conventions

- Correct spelling, grammar and punctuation.

Suggested Length:

- You should aim to write approximately 300-350 words.

Should we raise the retirement age?

Pro - Carl Lewis

The burden of rising health and aged-care costs in the Australian Federal budget has been identified by the Productivity Commission as a consequence of unforeseen healthcare costs and the impact of Australian's increasing longevity. The Commission reported recently that these significant costs to our budget had been underestimated and an estimated 21 per cent tax increase is needed to meet the shortfall in health and aged-care costs. The alternative is for the retirement age of our workforce to be raised.

The Productivity Commission Chairman, Peter Harris, stated recently, "We'd like to provide some better incentives for people to think about continuing to work, because an aging population will cost us." He went on to explain that when the aged-care pension was first introduced around 1900, people typically lived for about 13 years past retirement. By comparison, a person born in 1986 will live for nearly double that time past retirement.

Overall, Australians are prosperous and are living longer. The rising costs of healthcare for an aging population are a significant government expense. In addition, our government provides benefits to support our aging population, including the aged-care pension and healthcare card and subsidise a range of health and community services run by public and private providers and volunteers.

However, as Australians who are living longer, we also need to take some responsibility for the rising costs of our health and aged-care and not expect the government to shoulder the burden. As a community we must address this significant financial problem if we want to continue to live well into our older age and remain financially secure.

Con – Justin Banks

In response to Carl Lewis' letter I would like to ask, how is making people stay at work longer really going to help address our aging population's health and aged-care needs? I think the government's knee-jerk reaction is not substantiated by data showing the cost-benefit of raising the retirement age and does not acknowledge the complex issues that would need to be addressed to implement this change.

Recently the National Seniors Australia Chief Executive Officer, Michael O'Neil, suggested that simply raising the retirement age may not be the solution to this problem. Mr O'Neil stated workplace ageism is a significant problem for those aged in their late 50's and older and this is a barrier to employment for them. He explained that a person who loses their job at 55 will be out of work on average 72-plus weeks. It appears mandating when people retire is not going to change workplace attitudes towards hiring seniors and until there is a significant shift in this ageism, increasing the retirement age is not the solution.

COTA Australia, representing older people in the workforce, appears to agree there is no one simple answer to this complex issue. COTA Chief Executive, Ian Yates, stated removing age discrimination in the workplace should be a priority. He also offered an alternative to raising the retirement age by suggesting taxpayers, as a whole, could agree to pay significantly higher taxes which would result in a more generous pension as well as free health and aged-care services. Mr Yates also suggested that the alternative to paying more tax would be to implement a 'user-pays' system for our health and aged-care services which would place the financial burden on the individual rather than the government.



People who are aged 55 and older experience declining health and the strain of working could exacerbate their health issues and place a larger burden on the healthcare system. It seems that the suggestion of raising the retirement age to keep people working longer to cover rising health and aged-care costs could also create more healthcare problems.

Raising the retirement age is not the simple solution to the issue of rising health and aged-care costs. Extensive research, including a cost-benefit analysis, is required to demonstrate whether there would, in fact, be any financial gains. And we would also need to address the complex issues faced by seniors in the workplace to ensure that employment opportunities exist for seniors.

Sample Response

Note that this sample response is provided as a model only – it is not an exemplar or the only approach that could be used to write a response.

I agree with COTA Australia's opinion that there is no simple answer to this issue. We have an expectation to continue to live well beyond our working life but the warning from the Productivity Commission of the impact of increased longevity must be acted on.

However, to suggest that this issue has only two solutions – increasing taxes or raising the retirement age - is short-sighted. After reading both sides to this issue, I think a blended solution may be the best approach.

We need to re-assess the aged-care pension eligibility criteria. The current retirement age, and therefore access to the pension, is based on an arrangement established around 1900 and to assume this is still a good fit for today's society is foolish. As the Productivity Commission Chairman, Peter Harris, states, the post-retirement period has risen to around double what our current aged-care pension system was designed to service.

Michael O'Neil makes a good point that raising the retirement age will not necessarily ensure that seniors can continue working, even if they're required to. He explains that currently workplace attitudes towards hiring seniors is a barrier and this workplace ageism needs to be addressed before we can assume seniors will have access to employment opportunities.

We could tackle this issue by finding some middle ground. It may be that we require the retirement age to be raised marginally –e.g. not to age 70, but slightly above the current retirement age, perhaps age 67. This could be supported by government incentives for businesses to hire seniors, workplace programs to support seniors with increased leave to manage health-related issues.

The government should provide incentives for self-funded retirees by removing caps on tax-free superannuation contributions so that people can pay more into their superannuation funds while they're working. Increasing the number of self-funded retirees reduces the cost of the aged-care pension in the government's budget.

I believe it is through thoughtful, inclusive debate, careful analysis and measured decision-making that we will come to a solution. We must act with a range of sensible measures to ensure we have a solution to meet our economic needs now and for generations to come.

Oral Communication Task

As part of the Victoria Police entrance assessment, you will be required to complete an Oral Communication assessment task. You will watch a short piece of video footage. You will then be required to answer questions to demonstrate that you have comprehended what you saw and can talk about it appropriately.

Time allowed: 10 minutes.

Your task

Please watch the sample video carefully:

Car Strikes, I-95 Overpass in Fairfield - <http://vimeo.com/14132589>

Advice to Candidates

You will be assessed on the following points:

- showing an understanding of the footage and of the questions asked
- using correct English grammar when speaking
- using language appropriate to the task, including appropriate vocabulary, pronunciation and fluency
- organising and structuring your thoughts and ideas coherently to clearly describe and explain the footage and answer the questions
- using appropriate rhythm, stress and intonation (including speed of speech)
- supporting each point you make with relevant evidence

You will be assessed on your responses across all of the questions asked.

Questions

Answer the following questions about the footage:

- Describe what you observed.
- What emergency services were involved?
- Can you describe the car involved?
- Where did the accident happen?
- Where was the driver found?
- What is your opinion of what you observed?

Tips to help you prepare for the oral assessment

- Practise, practise and more practise – the more experience you have speaking about a specific event the easier it will become
- Find footage you can watch, for example, the news, YouTube footage etc. and practise verbally recounting what you see
- Practise speaking with another person - encourage the other person to be critical of how you present information
- Use a recording device to record your speech then listen to the recording - keep practising to improve on any issues
- Find someone you believe is a good speaker and ask them to review your recording.



Digital Literacy

Digital Literacy refers to the skills needed to use digital technologies to achieve personal goals, enhance employability and support education and training. Digital Literacy covers the physical operations of digital devices and the software operations in those devices. It incorporates the ability to search and navigate, create, communicate and collaborate, think critically, analyse information, and address security, safety and wellbeing issues when using a variety of digital technologies. These skills are essential for individuals to participate effectively in today's society.

The Digital Literacy assessment requires candidates to answer a set of questions and perform a series of activities on a computer. It provides evidence that candidates are confident and competent at using a range of digital devices, including computers, and that they understand and can manage and use the features of common software applications, can sensibly use the internet to search for and find relevant information, apply for services, or purchase goods, etc., and are aware of personal and private security and privacy issues related to living and working in the digital world.

The questions in the Digital Literacy assessment are mapped against the Australian Core Skills Framework (ACSF) – the Australian standards for adult literacy and numeracy.

When practicing this section you should aim to get at least 80% correct.

Time allowed: 20 minutes.



Sample Questions

QUESTIONS 1 AND 2



Download our paper on
SOLAR PANELS IN AUSTRALIA

DOWNLOAD NOW

Question 1

You want to search about whether it is a good idea to install solar panels on your house in NSW.

Are the following approaches to your search expression likely to help you find the best set of results?

Tick 'Yes' or 'No' for each statement.

Approach	Will this approach help?
Mainly use keywords such as solar, panels, Australia	Yes: <input type="checkbox"/> No: <input type="checkbox"/>
Use quotation marks such as "solar panels"	Yes: <input type="checkbox"/> No: <input type="checkbox"/>
Use capital letters such as SOLAR PANELS	Yes: <input type="checkbox"/> No: <input type="checkbox"/>

Question 2

You found a relevant PDF file on the internet that you want to save on to your computer for use later. You have downloaded and opened the document in Acrobat Reader.

Put the following tasks into their correct order to save the file on your computer.

Task actions

- Click on 'Save'
- Click on 'Save As'
- Click on 'File' in the software
- Find the folder where you want to save the file

Correct order of tasks

- _____
- _____
- _____
- _____



QUESTIONS 3 AND 4

At work you have been requested to analyse some data and statistics about sales figures, and report back to your manager.

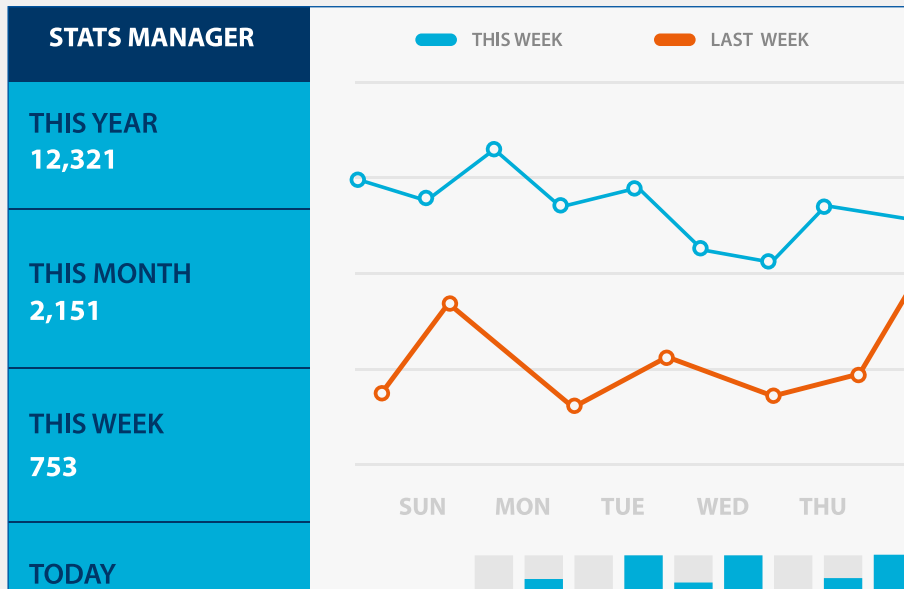

Question 3

Which of the following software packages would be the most useful for undertaking the analysis of the data?

- A A design package like Adobe Photoshop
- B A package like Adobe Acrobat Reader
- C A presentation package like MS PowerPoint
- D A spreadsheet package like MS Excel
- E A word processing package like MS Word

Question 4

Your manager wants you to report to the senior staff about the results of your analysis. Some of the staff will be logging in remotely.

Which of the following software packages would be the most useful for undertaking this task?

- A A design package like Adobe Photoshop
- B A package like Adobe Acrobat Reader
- C A presentation package like MS PowerPoint
- D A spreadsheet package like MS Excel
- E A word processing package like MS Word

QUESTIONS 5 AND 6

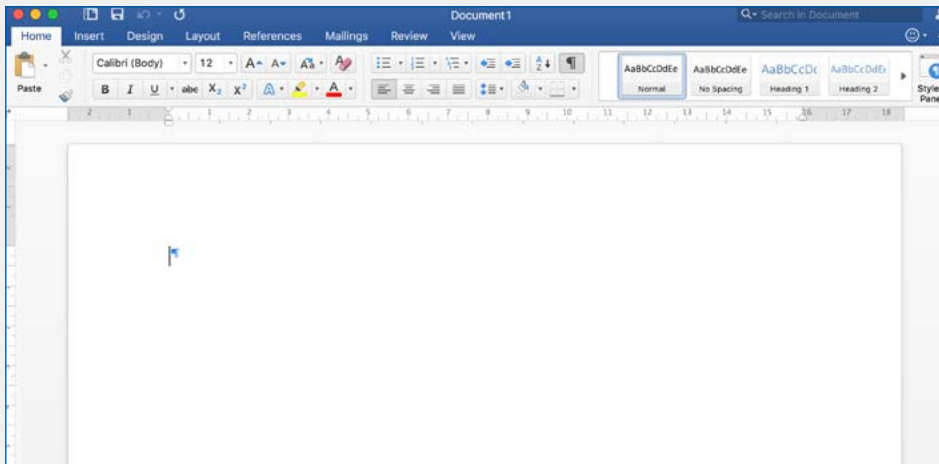

Question 5

You are wanting to check a document you have written, including for any spelling errors.

Which tab would you need to click on to do this?

- A Insert
- B Design
- C Page Layout
- D References
- E Mailings
- F Review
- G View

Question 6

You are wanting to make sure the document looks consistent with the same formatting and look throughout.

Which of the following statements are TRUE in relation to undertaking this task?

Tick 'True' or 'False' for each statement.

Statement	Is this statement TRUE or FALSE?
The Format Painter tool is very useful	True: <input type="checkbox"/> False: <input type="checkbox"/>
You need to use the options under the Review tab to help	True: <input type="checkbox"/> False: <input type="checkbox"/>
Using styles can help enormously	True: <input type="checkbox"/> False: <input type="checkbox"/>



Question 7

When you're shopping online, how do you know if the website is secure?

- A All online shopping websites are secure.
- B My strong password guarantees that my connection is secure.
- C The URL starts with 'https://' and there's a padlock icon in the address bar.
- D The words 'secure website' feature somewhere on the page.

Question 8

Which of the following is the safest way to access Wi-Fi when you are away from home or your office?

- A Only use Wi-Fi networks in reputable places, like shopping centres.
- B Set up your Wi-Fi on your device to Private Network.
- C Use a Virtual Private Network (VPN).
- D Use public Wi-Fi that is password protected.
- E Use a café or hotel's Wi-Fi network.

Sample Questions Answers

DIGITAL LITERACY

Q. 1	Yes, Yes, No
Q. 2	<ol style="list-style-type: none">1. Click on 'File' in the software2. Click on 'Save As'3. Find folder where you want to save the file4. Click on 'Save'
Q. 3	D.
Q. 4	C.
Q. 5	F.
Q. 6	True, False, True
Q. 7	C.
Q. 8	C.



Reasoning Test

VERBAL REASONING

- 1 Car is to land as ship is to
- A oar.
 - B sail.
 - C travel.
 - D sea.
 - E plane.
- 2 Sun is to day as moon is to
- A star.
 - B sky.
 - C night.
 - D clouds.
 - E satellite.
- 3 Four of the following are alike in some way. Check the boxes of the other two.
- A coat
 - B hat
 - C ball
 - D dress
 - E cup
 - F shoe
- 4 Four of the following are alike in some way. Check the boxes of the other two.
- A walk
 - B run
 - C skip
 - D sit
 - E jog
 - F sleep
- 5 Find the word that means most nearly the same as join.
- A mend
 - B connect
 - C choose
 - D like
 - E scatter



- 6 Find the word that means most nearly the same as slender.
- A loud
 - B untrue
 - C slim
 - D smooth
 - E young
- 7 Find the two statements which together prove that planes travel faster than ships.
- A Planes travel faster than trains.
 - B Some planes have jet engines.
 - C Ships travel on the water.
 - D Trains travel faster than ships.
 - E Some trains travel very fast.
- 8 Find the two statements which together prove that Bob Smith owns a car.
- A All employees at the Border Garage are mechanics.
 - B Everyone who works at the Border Garage owns a car.
 - C Bob Smith is a mechanic.
 - D Mechanics need to have a driver's licence.
 - E Bob Smith works at the Border Garage.



ABSTRACT REASONING

Practice Question 1

The three shapes in the top row are alike in some way. Which shape in the bottom row is most like them?

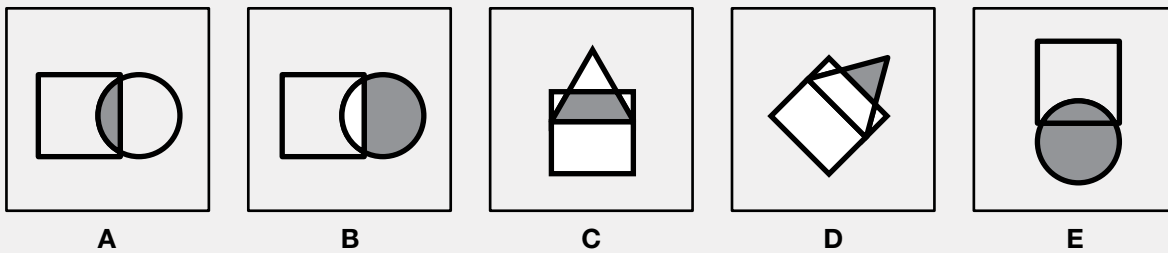
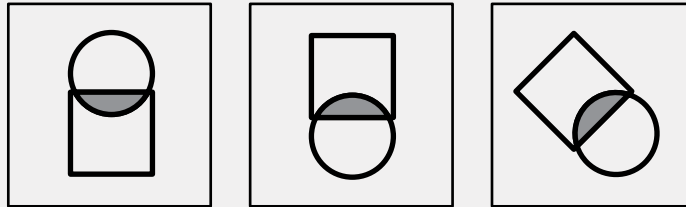

Practice Question 2

On the top row there are five squares with shapes arranged in order. One shape is missing. Which shape from the bottom row best completes the pattern?

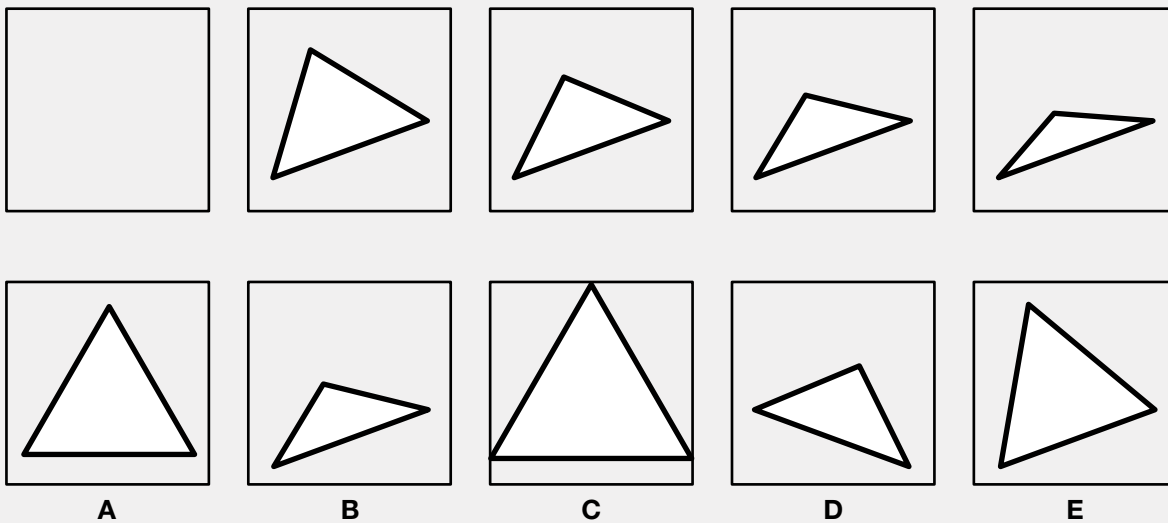

Practice Question 3

There is one missing shape in the pattern at the top. Which shape from the bottom row best completes the pattern?

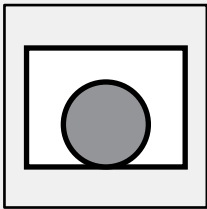
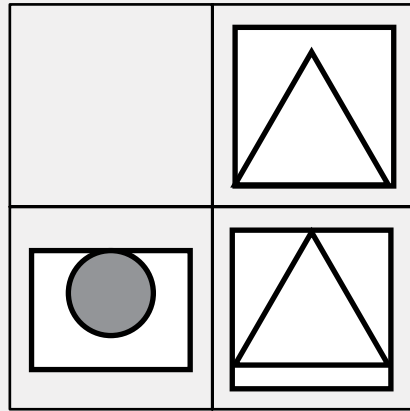

A

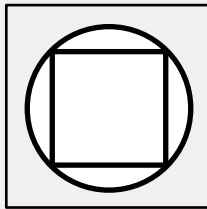

B

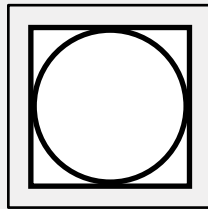

C

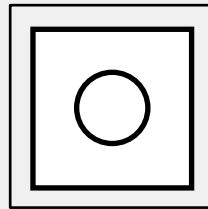

D

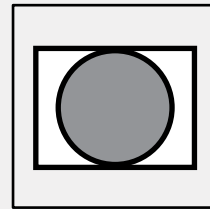

E



Numeracy Skills

Note: A basic scientific calculator can be used to practice for the Numeracy Skills assessment. An on screen calculator will be provided for the exam. No other calculators will be permitted for use during the exam.

Spraysaver showerhead



7.5 litres per minute

Steadyflow shower head

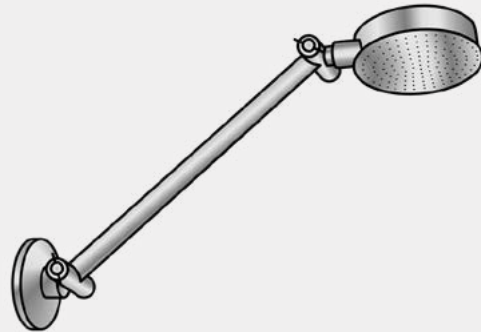

9 litres per minute

- 1 Gerard has a 5-minute shower every day. He has just changed his showerhead from the Steadyflow to the Spraysaver. How many litres (L) of water will he save each week?
- 2 Ruby uses a Spraysaver showerhead. Her water usage charge is \$2.50 per kilolitre. If Ruby has an 8-minute shower every day, how much will this add to her water bill every year?
Note: Assume 365 days in a year

The following graph shows the stopping distances for an average car. The reaction distance is the distance a car travels before the driver applies the brakes. The braking distance is the distance the car travels after applying the brakes. The stopping distance includes both the reaction distance and braking distance.

How long it takes to stop (driving an average family car)

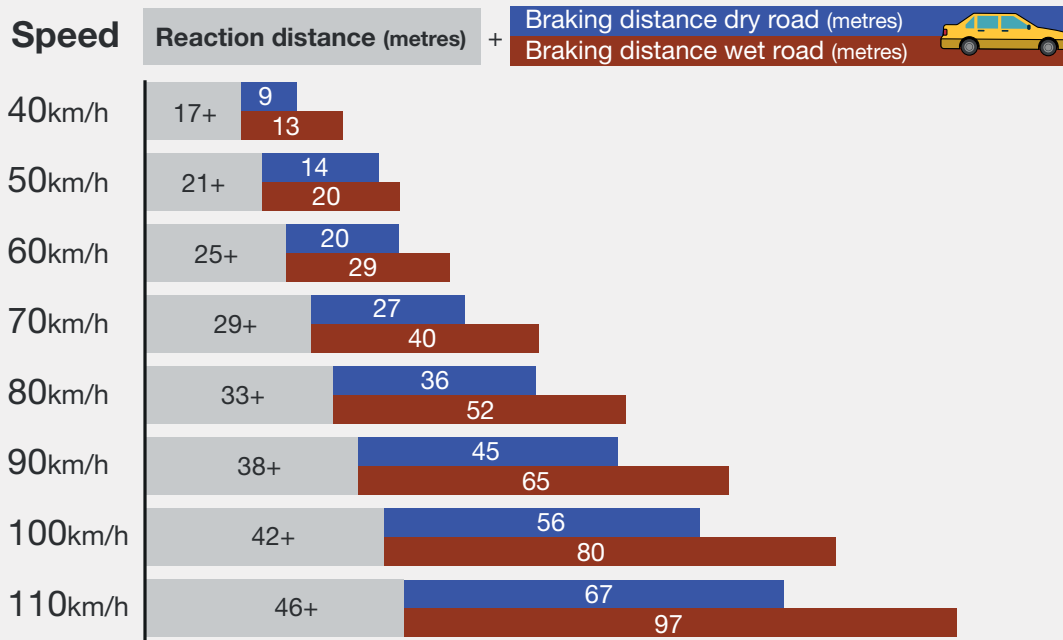

- 3 What would be the stopping distance for a car travelling at 80 kilometres per hour (km/h) on a dry road?

- 4 Which of the following would most likely be the reaction distance in metres (m) for a car travelling at 130 km/h?
 - A 48
 - B 50
 - C 54
 - D 58
 - E 62



Adut buys a car for \$19,990. Using the company's finance, her monthly repayments will be \$410 and she will repay the loan fully after 5 years.



5 How much interest will she have paid?

The value of the car depreciates at the following rates.

Vehicle Age (years)	Depreciation Rate (per year)
1	25%
2	15.6%
3	15.6%
4	15.6%
5	15.6%

6 If the price of the new car was \$19,990, how much would the car be worth after 4 years?

7 Trevor buys the same car for \$19,990 with a loan at a rate of 6% per year. The interest is calculated monthly on the amount owed on the loan.
If Trevor pays \$400 a month on his loan, how much will he still owe after 3 months? Note that the interest is calculated at the end of each month.

Donna is a landscape gardener. A client has asked her to make a planter box with the exterior, side dimensions below.



Donna is using bricks to make the base for the planter.

Standard Brick Dimensions

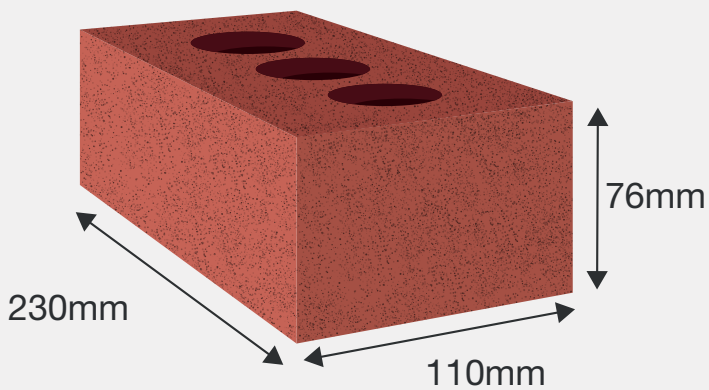

8 How many standard-sized bricks will Donna need to cover all of the planter's base?

The sides of the planter box will be built with timber sleepers. These come in 200 millimetre (mm) by 2400 mm lengths.

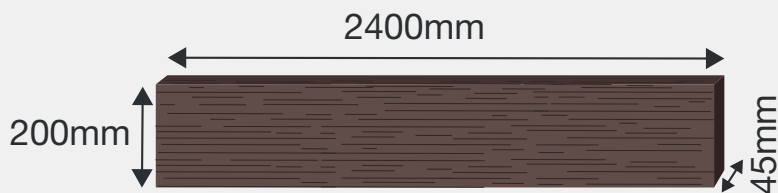

9 How many timber sleepers will Donna need?



The client has asked Donna to fill the planter box with soil so that the soil is $\frac{3}{4}$ of the way to the top.



10 How many 25 litre (L) bags of garden soil mix are needed to fill the plant box $\frac{3}{4}$ full?

Sample Questions Answers

LITERACY SKILLS (Reading)

1	C		
2	D		
3	C		
4	Will ruin a park	Yes	
	Will close off local streets during construction		No
	Trucks with dangerous loads will travel over houses	Yes	
5	B		
6	Eating a 50 grams of ham every day can make you 18% more likely to get cancer	Yes	
	The way that processed meat is cooked is a factor in how likely it is to cause cancer		Not stated
	Eating red meat definitely causes cancer		No
	Over 30000 people die every year from cancer linked to eating high levels of processed meat	Yes	
7	A		
8	A		
9	B		
10	C		

Note: The questions in the Literacy (Reading) assessment are mapped against the Australian Core Skills Framework (ACSF) – the Australian standards for adult literacy and numeracy. The results of the assessment are reported on a scale that goes from approximately 40 up to a maximum of about 170. A score of 111 or greater is considered a performance at Exit level 3 of the ACSF or higher and this is the required pass mark. In these sample questions this would mean you would need to get at least 60% of the questions correct to be at this level.



VERBAL REASONING

1	D - Sea
2	C - night
3	C - Ball; E - Cup
4	D -sit; F - sleep
5	B - connect
6	C - slim
7	A - Planes travel faster than trains; D - Trains travel faster than ships
8	B - Everyone who works at the Border Garage owns a car. E - Bob Smith works at the Border Garage.

ABSTRACT REASONING

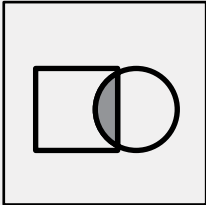
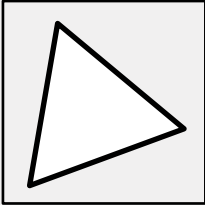
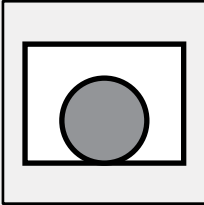
1	2	3
 A	 E	 A

NUMERACY

1	52.5L
2	\$54.75
3	69 metres
4	C 54
5	\$4610
6	\$9013.66 or correct rounding to nearest 10 cents (\$9013.70) or dollar (\$9014)
7	\$19,085.34 or correct rounding to the nearest 10 cents (\$19,085.30) or dollar (\$19,085)
8	34 bricks
9	4 sleepers
10	8 Bags

Note: The questions in the Numeracy assessment are mapped against the Australian Core Skills Framework (ACSF) – the Australian standards for adult literacy and numeracy. The results of the assessment are reported on a scale that goes from approximately 40 up to a maximum of about 170. A score of 111 or greater is considered a performance at Exit level 3 of the ACSF or higher and this is the required pass mark. In these sample questions this would mean you would need to get at least 60% of the questions correct to be at this level.



Legal Notice

1. By completing and submitting the registration form for the VICTORIA POLICE ENTRANCE EXAMINATION test located at <http://vpol@acer.org> You are offering to enter into a legal agreement with the Australian Council for Educational Research Ltd (ABN 19 004 398 145) (ACER);

2. The **TERMS AND CONDITIONS** which will apply to Your application for registration and to Your registration to participate in the VICTORIA POLICE ENTRANCE EXAMINATION test are contained in this Booklet, including this Legal Notice. The Terms and Conditions cover, amongst other things, Your sitting the VICTORIA POLICE ENTRANCE EXAMINATION test, payment of the registration fee, refunds of fees, access to VICTORIA POLICE ENTRANCE EXAMINATION Preparation Materials and release of the VICTORIA POLICE ENTRANCE EXAMINATION test results;

3. Before lodging Your Registration, You should make sure You understand fully and are familiar with the contents of this Booklet, including this Legal Notice;

4. You may have legal rights and guarantees under the Australian Consumer Law (being Schedule 2 to the *Competition and Consumer Act 2010* (Cth), as amended from time to time). If the publication of this Booklet or Your registration for or participation in the VICTORIA POLICE ENTRANCE EXAMINATION test involves a supply of goods or services to a consumer within the meaning given in the Australian Consumer Law, nothing contained in this Booklet excludes, restricts or modifies the application of any consumer guarantee provided in the Australian Consumer Law, the exercise of any right or remedy in respect of, or the imposition of any liability for the failure to comply with any relevant guarantee.

5. Subject to point 4:

a. To the maximum extent permissible by law (and for the avoidance of doubt, subject to any guarantees, rights, remedies or obligations which cannot be excluded, restricted or modified under the Australian Consumer Law), ACER expressly, irrevocably and totally disclaims any liability whatsoever for any loss or damage whatsoever and howsoever arising in connection with or resulting from: Your participation (actual, potential, contemplated or cancelled for any reason whatsoever) in the VICTORIA POLICE ENTRANCE EXAM; and Your test results, including, but not limited to, any representations made by ACER

or its personnel (including agents, subcontractors and consultants) in respect of VICTORIA POLICE ENTRANCE EXAMINATION and the accuracy of any information contained in this Booklet;

b. To the fullest extent permitted at law, You acknowledge and accept that the entire risk of Your participation in VICTORIA POLICE ENTRANCE EXAMINATION is assumed by You and that ACER will have no liability whatsoever to You for any loss, harm, damage, cost or expense (including legal fees) or any direct, special, indirect, incidental, punitive or consequential loss or damage (including, without limitation, economic loss, loss of contract, profit, revenue, income, opportunity, goodwill, information, anticipated savings, business relationships, production or data) whatsoever and howsoever arising;

c. You acknowledge and accept that, to the fullest extent permitted at law, ACER gives NO WARRANTY or guarantee and makes no representation whatsoever that: registering for or sitting the VICTORIA POLICE ENTRANCE EXAMINATION test will guarantee You or secure for You a placement with the Victoria Police; or that You will be provided with Your VICTORIA POLICE ENTRANCE EXAMINATION results (other than in strict accord with this Agreement).

To the fullest extent permitted at law, You release and fully indemnify ACER, its officers, employees and agents from and against all claims, liabilities, costs, demands and expenses whatsoever and howsoever arising from or in connection with:

Your registration for or participation (actual, potential, contemplated or cancelled) in the VICTORIA POLICE ENTRANCE EXAM; or

Any breach by You of the terms and conditions of Your participation (actual, potential, contemplated or cancelled) in the VICTORIA POLICE ENTRANCE EXAM.

These releases and indemnities survive Your participation (actual, contemplated, potential or cancelled) in the VICTORIA POLICE ENTRANCE EXAMINATION and whether or not You are offered or accept a placement with Victoria Police for any position whatsoever.

In the event that any law implies terms or guarantees into the offering or conduct of the VICTORIA POLICE ENTRANCE EXAMINATION which cannot be lawfully excluded, restricted or modified, such terms or guarantees will apply,



save that the liability of ACER for breach of any such term or guarantee will, to the extent legally permitted, be limited to the refund of the price paid for any relevant goods or services.

ACER has made every effort to ensure the accuracy of the information provided in this Booklet. , ACER reserves the right to alter or amend any detail contained in the Booklet in its absolute and unqualified discretion. Any alteration or amendment will take effect immediately upon publication of the alteration or amendment on <http://vpol@acer.org>.

9. PRIVACY, PERSONAL INFORMATION and SENSITIVE DATA: By completing the VICTORIA POLICE ENTRANCE EXAMINATION registration form You agree to be bound by the ACER privacy policy and You consent to:

- a. ACER collecting Your personal information including any sensitive (such as health) information and other information. The information ACER may collect about You includes Your registration information, Your payment details, Your test answers and results, any application for special testing conditions and any communications You have with the ACER VICTORIA POLICE ENTRANCE EXAMINATION Office;
- b. ACER using and disclosing the personal information and other information it collects about You for purposes connected with Your VICTORIA POLICE ENTRANCE EXAMINATION registration and testing which may include investigating any suspected misconduct and determining and administering any consequences for misconduct. You understand that if You do not provide us with all the information requested, ACER may not be able to process Your VICTORIA POLICE ENTRANCE EXAMINATION registration or test or respond to Your communications;
- c. Your personal (including sensitive) information and other information provided being disclosed by ACER to the VICTORIA POLICE, and other persons or bodies connected with VICTORIA POLICE for purposes related to VICTORIA POLICE recruitment (which may include transferring it overseas); and
- d. ACER using Your personal information for research purposes and disclosing it to relevant research bodies (in a de-identified form). Candidate names will be separated from data in all cases. All information collected will be treated with utmost confidentiality and we will take all reasonable steps to ensure its

security. Any use of Your registration and test records will be treated with the utmost confidentiality.

In all respects, ACER will comply with all relevant provisions of the Privacy Act 1988 (Cth) and any other applicable data protection legislation. For a complete copy of ACER's privacy policy and how to access or correct Your information, please see <https://www.acer.org/privacy>.

10. By completing and submitting the VICTORIA POLICE ENTRANCE EXAMINATION registration form:

- a. You confirm that You have read in its entirety and accept the contents of this Booklet, including the Legal Notice;
- b. You confirm Your agreement with the terms and conditions contained in this Booklet; and
- c. You acknowledge that You have been entitled to obtain legal advice concerning any matter covered in this Booklet, whether or not You have in fact sought any legal advice.
- d. You acknowledge and accept that this Booklet contains the entire agreement between You and ACER concerning Your participation in the VICTORIA POLICE ENTRANCE EXAMINATION and that no matter, information or representation not expressly contained in this Booklet has induced You or had any bearing on You to seek registration for the VICTORIA POLICE ENTRANCE EXAM.
- e. You accept and unconditionally undertake to strictly comply with the terms and conditions contained in this Booklet.
- f. You acknowledge and accept that Your agreement with ACER will be governed by the laws of the State of Victoria, Australia;
- g. You submit to the jurisdiction of the Courts chosen by ACER and any of the Courts of Appeal there from to determine any dispute (whether as to the interpretation of Your agreement with ACER, or any matter concerning performance or compliance of the agreement or otherwise) or to determine any claims brought or made against You by ACER or its authorised nominee



Contact details

Vic Pol Office at ACER:

Email: vicpol@acer.org

Web: <https://vpol.acer.org>

Phone: (03) 9277 5299

Postal address: Private Bag 55,
Camberwell VIC 3124



VICTORIA POLICE